



EXTRA
ORDINARY SIZE

M A R M I

UNA GRANDE VERSATILITÀ PER OGNI CAMPO DI APPLICAZIONE

Great versatility in all fields of application
 Une grande polyvalence pour tout domaine d'application
 Eine grosse Vielseitigkeit für jeden Anwendungsbereich
 Una gran versatilidad para cada campo de aplicación
 Высокая универсальность в любой сфере применения
 在任何应用场合广泛的适用性

Con i grandi formati si possono realizzare tagli di qualunque forma e dimensione, per ampliare ulteriormente le possibilità di utilizzo della lastra andando dal pavimento per arrivare al rivestimento di pareti, mobili, tavoli, piani, ante.

With large sizes, you can make cuts of any shape and size, to further extend the possibilities of use of the slab covering floors, walls, furniture, tables and doors.

Avec les grands formats on peut réaliser des coupes de toute forme et toute dimension, pour élargir ultérieurement la gamme d'utilisations de la plaque, en partant du revêtement de sol pour arriver au revêtement de parois, meubles, tables, plans et portes.

Mit Großformaten sind beliebig große Schnitte in unterschiedlichsten Formen möglich und die Anwendungsmöglichkeiten der Platte werden noch umfangreicher, von Böden bis hin zur Verkleidung von Wänden, Möbeln, Tischen, Flächen und Türen.

Con los grandes formatos se pueden realizar cortes de cualquier forma y dimensión para ampliar ulteriormente las posibilidades de uso de la losa, que abarca desde el pavimento hasta llegar al revestimiento de paredes, muebles, mesas, superficies y puertas.

Из больших форматов всегда можно создавать меньшие форматы любых форм и размеров, все более расширяя возможности применения плиты: от пола до облицовки стен, мебели, поверхностей, створок.

采用大规格的板材，可以随意切割成各种形状和尺寸的板材，进一步扩大板材的应用范围，可应用在地板、墙面装饰、家具、桌面、平台和窗板。

WALL & FLOOR

PAVIMENTO E RIVESTIMENTO

Floor and covering. Revêtement sols et murs.
 Boden und Verkleidungen. Pavimento y revestimiento.
 Полы и облицовка. 地板及墙面。



MARMI / CREMA MARFIL

FURNITURE AND DESIGN

TOP E RIVESTIMENTI COORDINATI

Coordinated top and covering. Top et revêtements coordonnés.
 Tops und koordinierte Verkleidungen. Encimeras y revestimientos coordinados.
 Комплекты столешниц и облицовок. 顶面及辅助装饰。



MARMI / CALACATTA

FURNITURE AND DESIGN

ARREDAMENTO E DESIGN

Furnishings. Ameublement.
 Einrichtung. Decoración.
 Оформление помещений. 装修。



MARMI / CALACATTA

FURNITURE AND DESIGN

PORTE E ANTE

Shutters and doors. Portes et battants.
 Türen und Schranktüren. Puertas y hojas.
 Двери и створки. 门和窗板。



MARMI / CALACATTA

BUSINESS TO BUSINESS

PISCINE

Swimming pools. Piscines.
 Schwimmbäder. Piscinas.
 Бассейны. 泳池。



MARMI / CALACATTA
 CONTEMPORANEI / SKYLINE

BUSINESS TO BUSINESS

CONTRACT

Контрактные поставки.
 协议。



MARMI / CALACATTA

BUSINESS TO BUSINESS

FACCIAE VENTILATE E INCOLLATE

Adhesive-mounted curtain walls. Façades ventilées et collées.
 Hinterlüftete und verklebte Fassaden. Fachadas ventiladas y encoladas.
 Вентилируемые и наклеенные фасады. 胶合通风外墙。

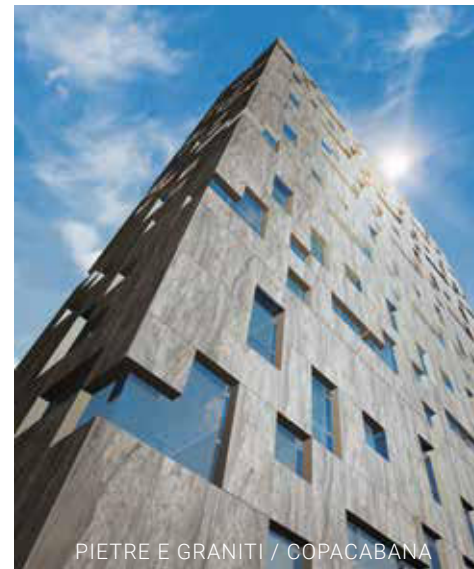

PIETRE E GRANITI / COPACABANA

BUSINESS TO BUSINESS

INDUSTRIA NAVALE

Shipping industry. Industrie navale.
 Schiffbauindustrie. Industria naval.
 Кораблестроение. 船舶工业。

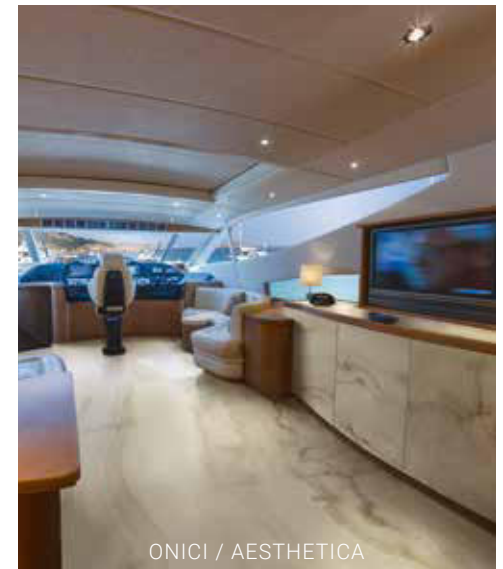

ONICI / AESTHETICA

MARMICALACATTA 320x160 - 126"x63" LAP. RET.



MARMICALACATTA 320x160 - 126"x63" LAP. RET.



CONTEMPORANEIDISTRICT TORTORA 320x160 - 126"x63" NAT. RET.



MARMICALACATTA 320x160 - 126"x63" LAP. RET.



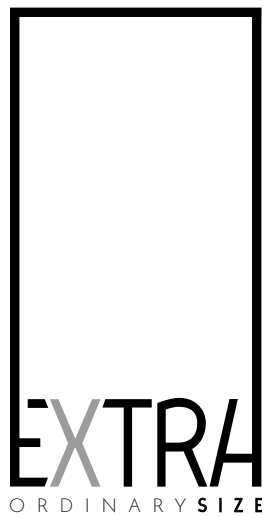

LASTRE IN GRES PORCELLANATO PRESSATE A SECCO.

Dry-pressed porcelain stoneware slabs.

Dalles en grès cérame pressées à sec.

Trockengepresste Platten aus Feinsteinzeug.

Planchas en gres porcelánico prensadas en seco.

Керамогранитные плиты сухого прессования.

干压陶瓷砖.

SHADE SPECTRUM

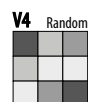
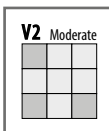
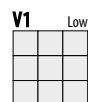

Spessore. Thickness. Epaisseur. Stärke. Espesor. Толщина. 厚度.

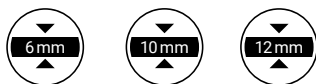

100% DESIGN
AND PRODUCTION
OF ITALY



I N D E X

EXTRA COLORS

08 / ARABESQUE

08 / AZUL MACAUBA

09 / BIANCO BERNINI

09 / BARDIGLIO CENERE

10 / CALACATTA

10 / CREMA MARFIL

11 / LASA

11 / NERO BELVEDERE

12 / STATUARIO

12 / STATUARIO SPLENDEnte

13 / TRAVERTINO SILVER

13 / WHITE MACAUBA

42 / TECHNICAL FEATURES



ARABESQUE

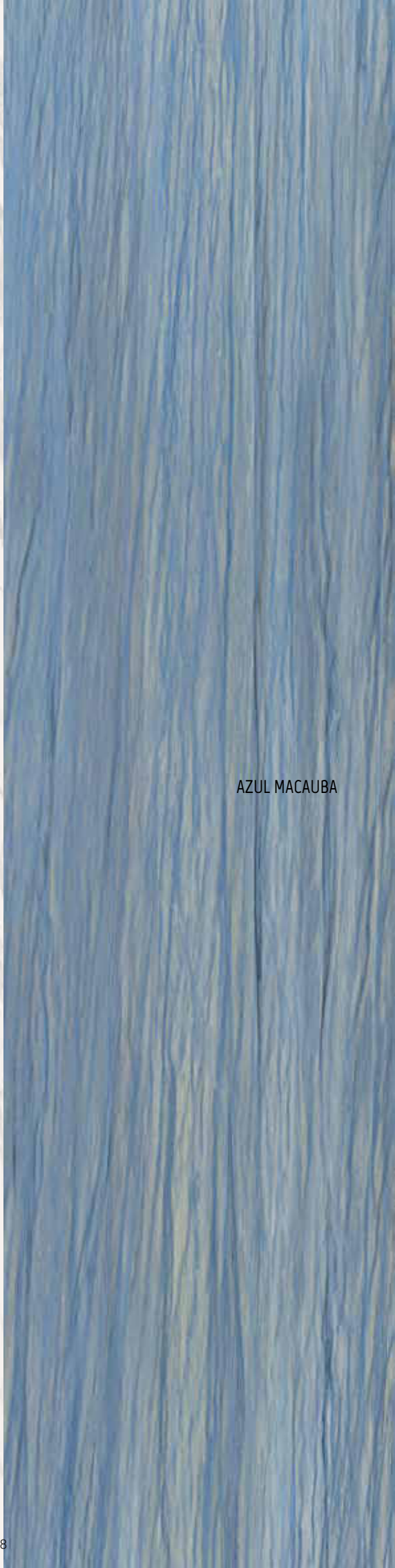

AZUL MACAUBA



BARDIGLIO CENERE



BIANCO BERNINI



CALACATTA



CREMA MARFIL



LASA

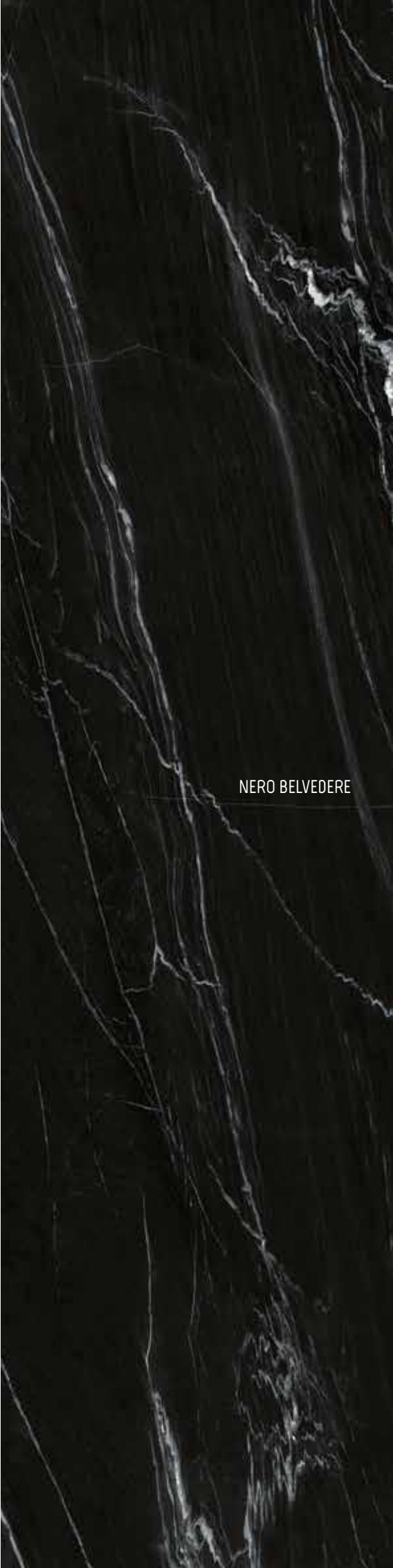

NERO BELVEDERE



STATUARIO



STATUARIO SPLENDEnte

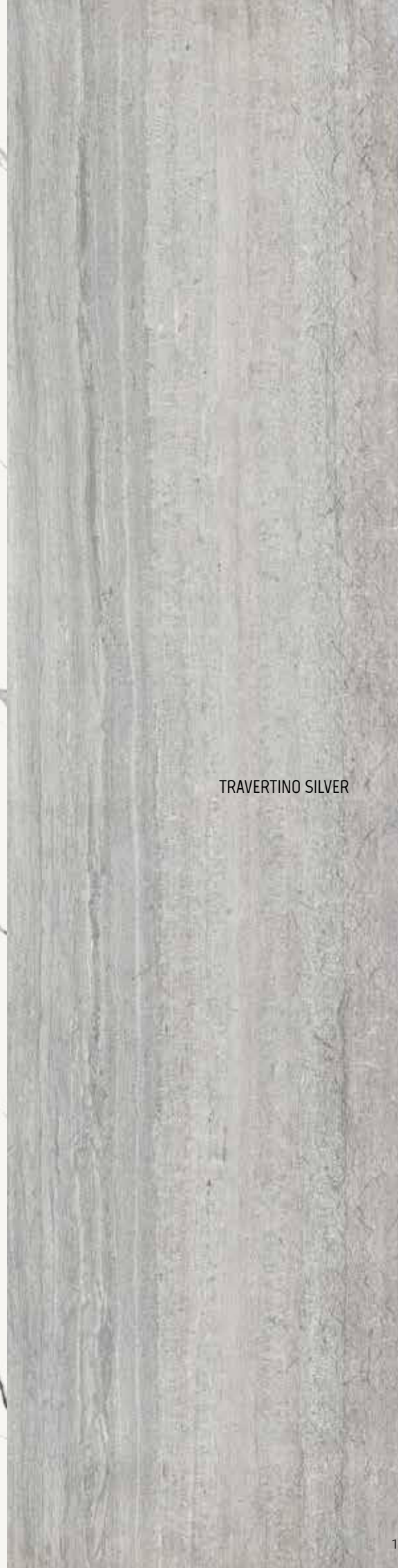

TRAVERTINO SILVER



WHITE MACAUBA



MARMI AZUL MACAUBA 320 x 160 - 126" x 63" LAP. RET.
MARMI LASA 320 x 160 - 126" x 63" LAP. RET.

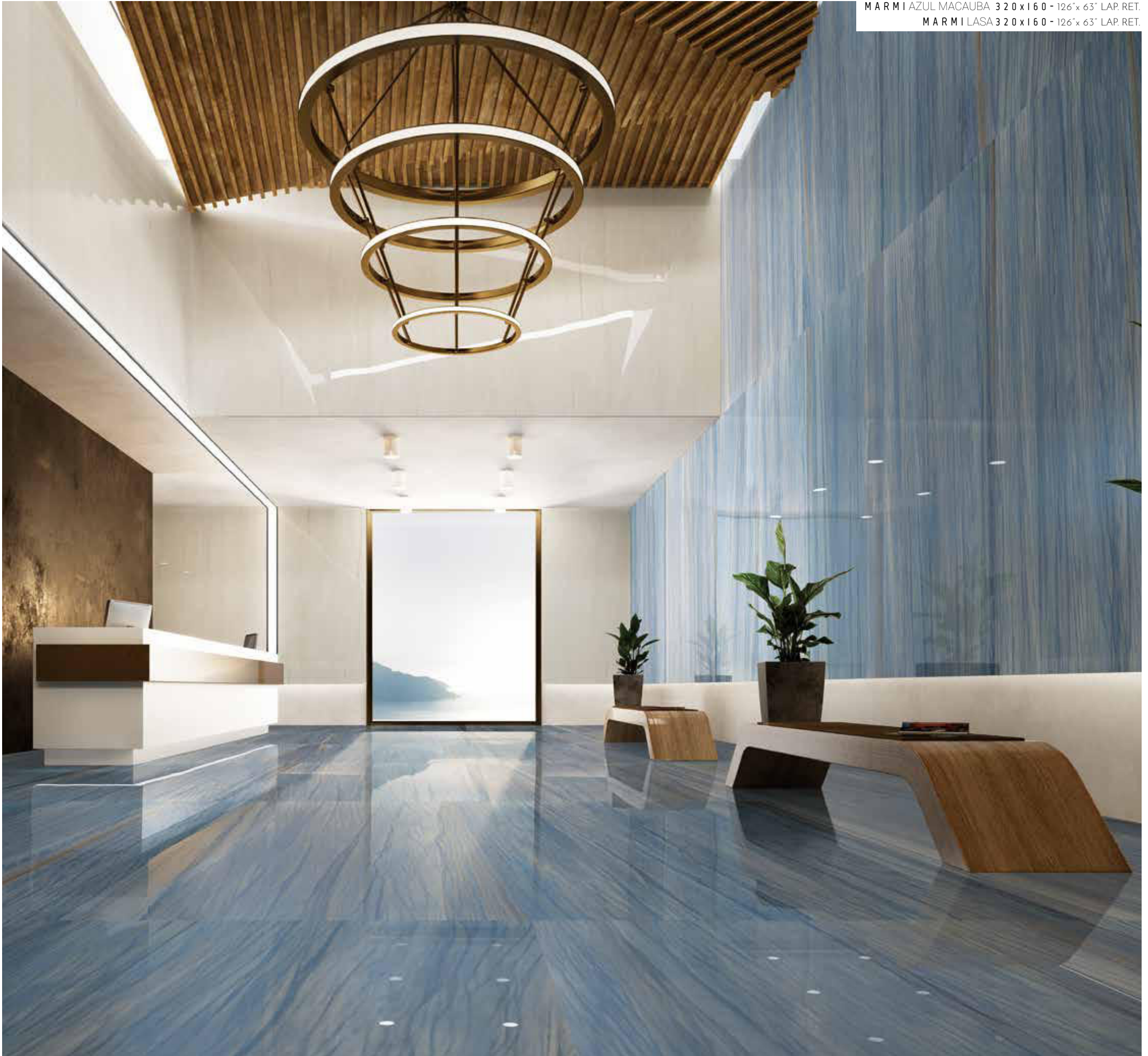



Slab A e B

Due grafiche identiche ma speculari per creare nuovi elementi decorativi.

ESEMPI DI COMPOSIZIONI

Layout examples. Des exemples de compositions. Gestaltungsbeispiele. Ejemplos de composición. Примеры композиций. 地板及墙面。

Two identical graphics with a mirror image concept to create new decorative elements.
Deux graphismes identiques mais spéculaires pour créer de nouveaux éléments décoratifs.
Zwei identische, aber spiegelbildliche Graphiken, um neue Dekorelemente zu schaffen.
Dos gráficas idénticas pero especulares para crear nuevos elementos decorativos.
Два идентичных, но зеркально противоположных варианта графики для создания новых декоративных элементов.
两块相同的镜面图案以产生新的装饰元素。

320x160 cm . 126"x63"

Esempio 1 / Example 1



Esempio 2 / Example 2



Esempio 3 / Example 3



Esempio 4 / Example 4



240x120 cm . 96"x48"

Esempio 1 / Example 1

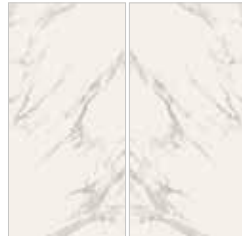

Esempio 2 / Example 2



Esempio 3 / Example 3



Esempio 4 / Example 4



MARMI CALACATTA SLAB A - B 320x160 - 126"x63" LAP. RET.

MARMI CALACATTA 320x160 - 126"x63" LAP. RET.

CONTEMPORANEI SKYLINE ANTRACITE 320x160 - 126"x63" NAT. RET.





M A R M I N E R O B E L V E D E R E 3 2 0 x 1 6 0 - 1 2 6 " x 6 3 " L A P . R E T .
M A R M I S T A T U A R I O S P L E N D E N T E 3 2 0 x 1 6 0 - 1 2 6 " x 6 3 " L A P . R E T .
M A R M I S T A T U A R I O S P L E N D E N T E S L A B A - B 3 2 0 x 1 6 0 - 1 2 6 " x 6 3 " L A P . R E T .



Slab A e B

Due grafiche identiche ma speculari per creare nuovi elementi decorativi.

ESEMPI DI COMPOSIZIONI

Layout examples. Des exemples de compositions. Gestaltungsbeispiele. Ejemplos de composición. Примеры композиций. 地板及墙面。

Two identical graphics with a mirror image concept to create new decorative elements.
Deux graphismes identiques mais spéculaires pour créer de nouveaux éléments décoratifs.
Zwei identische, aber spiegelbildliche Graphiken, um neue Dekorelemente zu schaffen.
Dos gráficas idénticas pero especulares para crear nuevos elementos decorativos.
Два идентичных, но зеркально противоположных варианта графики для создания новых декоративных элементов.
两块相同的镜面图案以产生新的装饰元素。

320x160 cm . 126"x63"

Esempio 1 / Example 1



Esempio 2 / Example 2



Esempio 3 / Example 3



Esempio 4 / Example 4



240x120 cm . 96"x48"

Esempio 1 / Example 1



Esempio 2 / Example 2



Esempio 3 / Example 3



Esempio 4 / Example 4

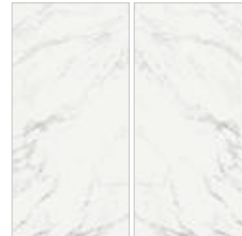

MARMI STATUARIO SLAB A - B 320x160 - 126"x63" LAP. RET.

MARMI STATUARIO 320x160 - 126"x63" LAP. RET. / 160x160 - 63"x63" LAP. RET.



Slab A e B

Due grafiche identiche ma speculari per creare nuovi elementi decorativi.

ESEMPI DI COMPOSIZIONI

Layout examples. Des exemples de compositions. Gestaltungsbeispiele. Ejemplos de composición. Примеры композиций. 地板及墙面。

Two identical graphics with a mirror image concept to create new decorative elements.
Deux graphismes identiques mais spéculaires pour créer de nouveaux éléments décoratifs.
Zwei identische, aber spiegelbildliche Graphiken, um neue Dekorelemente zu schaffen.
Dos gráficas idénticas pero especulares para crear nuevos elementos decorativos.
Два идентичных, но зеркально противоположных варианта графики для создания новых декоративных элементов.
两块相同的镜面图案以产生新的装饰元素。

320x160 cm . 126"x63"

Esempio 1 / Example 1



Esempio 2 / Example 2



Esempio 3 / Example 3



Esempio 4 / Example 4

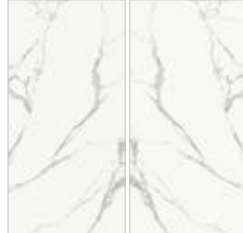

240x120 cm . 96"x48"

Esempio 1 / Example 1



Esempio 2 / Example 2



Esempio 3 / Example 3



Esempio 4 / Example 4



M A R M I STATUARIO SPLENDEnte 3 2 0 x 1 6 0 - 126"x63" LAP. RET.

M A R M I STATUARIO SPLENDEnte SLAB A - B 3 2 0 x 1 6 0 - 126"x63" LAP. RET.





PARETI VENTILATE

VENTILATED WALLS

La Fabbrica SpA
è in grado di fornire, chiavi in
mano tramite i suoi partner
distributori, l'installazione di
una parete ventilata ad alta
tecnologia produttiva, unica
nel suo genere,
a fuga "zero nominale".

[fuga reale 0.7 mm., Brevetto n. TO2006A000548]

Through its distributors, La Fabbrica SpA offers customers a turnkey solution for the installation of a unique "seamless" curtain wall, manufactured using advanced technology (0.7 mm joint system covered by patent number TO2006A000548).

La Fabbrica SpA est en mesure d'installer, clés en main, par l'intermédiaire de ses partenaires distributeurs, une paroi ventilée à haute technologie de production, unique en son genre, avec un joint "zéro nominal" [joint réel 0,7 mm, Brevet n° TO2006A000548].

Die Firma La Fabbrica SpA ist in der Lage die Montage einer hinterlüfteten Fassade mit modernster sowie einzigartiger Produktionstechnologie und Fuge "theoretisch Null" (reelle Fuge 0,7 mm, Patent Nr. TO2006A000548) schlüsselfertig über ihre Vertriebspartner zu liefern.

La Fabbrica SpA está en condiciones de realizar con entrega llave en mano a través de sus propios colaboradores distribuidores, la instalación de una pared ventilada de alta tecnología productiva, única en su género, con junta "cero nominal" [junta real 0,7 mm, patente n. TO2006A000548].

Через своих партнеров и дистрибьюторов La Fabbrica SpA может осуществлять установку "под ключ" уникального в своем роде вентилируемого фасада, в котором использованы высокие производственные технологии, с "нулевым номинальным" швом (фактический размер шва - 0,7 мм, патент № TO2006A000548)

La Fabbrica SpA 股份公司能通过其合作伙伴提供高科技通风墙，同类独创，“基本零”厚度（实际厚度 0,7 毫米，专利号码 TO2006A000548）。

MARMI WHITE MACAUBA 160x80 - 63"x31 1/2" LAP. RET.



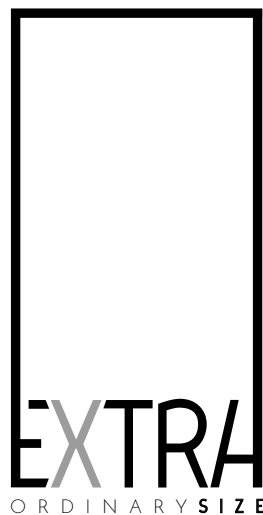

SHADE SPECTRUM

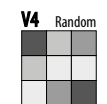
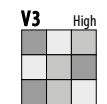
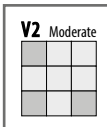
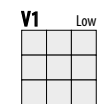

□ **Naturale e rettificato.**
Natural and rectified.
Naturel et rectifié.
Natur Oberfläche und kalibriert.
Natural y rectificado.
Натуральный ректифицированный.
天然和抛光。

○ **Lappato e rettificato.**
Lappato and rectified.
Lappato et rectifié.
Lappato und kalibriert.
Lappato y rectificado.
Лаппатированный ректифицированный.
亚光和抛光。

■ **Naturale.**
Natural.
Naturel.
Natur natur.
Natural.
Натуральный.
天然。

● **Lappato con bordi naturali.**
Lappato with non rectified edges.
Lappato à bords naturels.
Lappato mit natürlichen Kanten.
Pulido con los bordes natural.
Лаппатированная поверхность с матовой кромкой.
抛光带天然磨边。

LASTRE IN GRES PORCELLANATO PRESSATE A SECCO.

Dry-pressed porcelain stoneware slabs.
Dalles en grès cérame pressées à sec.
Trockengepresste Platten aus Feinsteinzeug.
Planchas en gres porcelánico prensadas en seco.
Керамогранитные плиты сухого прессования. 干压陶瓷砖。

UNI EN 14411-ISO 13006 appendice C gruppo BIa - UGL



ARABESQUE

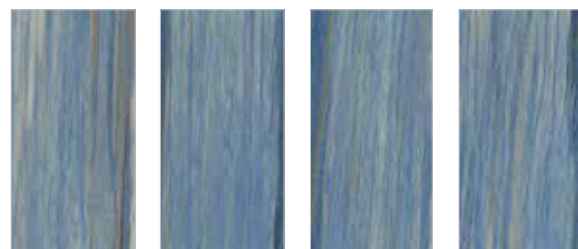

AZUL MACAUBA



BIANCO BERNINI

Grande varietà nelle grafiche per un pavimento o rivestimento sempre vario a effetto "naturale". The collection is available in a wide variety of graphics for varied floor or wall solutions with a "natural" effect. Grande variété des graphiques pour un carrelage de sol ou un revêtement mural toujours différent et un effet "naturel". Große Vielfalt der Graphiken für einen ständig unterschiedlichen Boden- oder Wandbelag mit "natürlichem" Effekt. Gran variedad en las gráficas para un pavimento o revestimiento siempre diferente de efecto "natural". Предлагается большое разнообразие рисунков для укладки всегда меняющегося пола или облицовки с натуральным эффектом. 多样的图案让地板和涂层具有不同的“天然”色彩。

Spessore. Thickness. Epaisseur. Stärke. Espesor. Толщина. 厚度 6mm - 10mm - 12mm

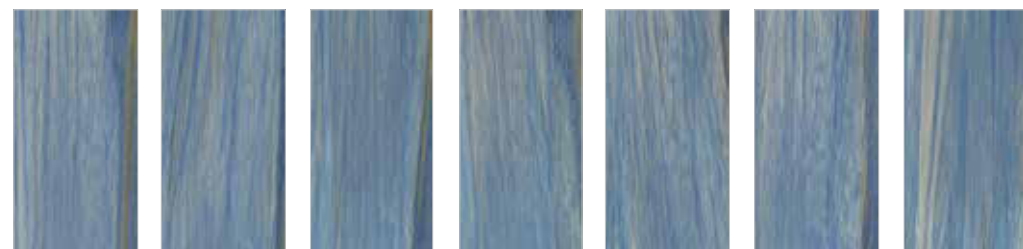

			320x160 126"x63" 6 mm	240x120 96"x48" 6 mm	160x160 63"x63" 6 mm	120x120 48"x48" 6 mm	160x80 63"x31 1/2" 6 mm	240x80 96"x31 1/2" 6 mm	80x80 31 1/2"x31 1/2" 6 mm	120x60 48"x24" 10 mm	60x60 24"x24" 10 mm	324x163 127"x64" 12 mm
Arabesque	○ Lap. Ret. 6mm	087015	087035	087051	087071	087091	-	087111	-	-	-	-
	○ Lap. Ret. 10mm	-	-	-	-	-	-	-	-	087130	087150	-
Azul Macauba	○ Lap. Ret. 6mm	087001	087021	087041	087061	087081	-	087101	-	-	-	-
	□ Nat. Ret. 6mm	087002	087022	087042	087062	087082	-	087102	-	-	-	-
	○ Lap. Ret. 10mm	-	-	-	-	-	-	-	-	087121	087141	-
	□ Nat. Ret. 10mm	-	-	-	-	-	-	-	-	087122	087142	-
										*(min. 2.000 mq)	*(min. 2.000 mq)	
Bianco Bernini	○ Lap. Ret. 6mm	083001	083011	083021	083031	083041	-	083051	-	-	-	-
	□ Nat. Ret. 6mm	083002	083012	083022	083032	083042	-	083052	-	-	-	-
	○ Lap. Ret. 10mm	-	-	-	-	-	-	-	-	083061	083081	-
	□ Nat. Ret. 10mm	-	-	-	-	-	-	-	-	083062	083082	-
										*(min. 2.000 mq)	*(min. 2.000 mq)	

Lo spessore della lastra stuoiata è 12,7 mm. The thickness of the mesh-mounted slab is 12,7 mm. L'épaisseur de la dalle montée sur filet est de 12,7 mm. Die Dicke der Platte mit Netz ist 12,7 mm. El espesor de las losas, malla incluida, es de 12,7 mm. Толщина плиты с сеткой составляет 12,7 мм. 铺垫后的板材厚度为12.7毫米。

*Articolo disponibile per progetti (ordine minimo circa 2.000mq). Article available for large-scale projects (minimum order: approximately 2,000 m²). Article disponible pour les projets (commande minimale environ 2000 m²). Für Projekte verfügbarer Artikel (Mindestbestellung ca. 2.000 qm.). Artículo disponible para proyectos (pedido mínimo aproximadamente 2.000 m²). Этот артикул поставляется для крупных проектов (минимальный заказ – около 2000 кв.м.). 依项目而定的产品 (最小订单约2000平方米)。

EXTRA

ORDINARY SIZE

LASTRE IN GRES PORCELLANATO PRESSATE A SECCO.

Dry-pressed porcelain stoneware slabs.
Dalles en grès cérame pressées à sec.
Trockengepresste Platten aus Feinsteinzeug.
Planchas en gres porcelánico prensadas en seco.
Керамогранитные плиты сухого прессования. 干压陶瓷砖。

UNI EN 14411-ISO 13006 appendice C gruppo BIa - UGL

Grande varietà nelle grafiche per un pavimento o rivestimento sempre vario a effetto "naturale". The collection is available in a wide variety of graphics for varied floor or wall solutions with a "natural" effect. Grande variété des graphiques pour un carrelage de sol ou un revêtement mural toujours différent et un effet "naturel". Große Vielfalt der Graphiken für einen ständig unterschiedlichen Boden- oder Wandbelag mit "natürlichem" Effekt. Gran variedad en las gráficas para un pavimento o revestimiento siempre diferente de efecto "natural". Предлагается большое разнообразие рисунков для укладки всегда меняющегося пола или облицовки с натуральным эффектом. 多样的图案让地板和涂层具有不同的“天然”色彩。

Spessore. Thickness. Epaisseur. Stärke. Espesor. Толщина. 厚度 6mm - 10mm - 12mm



BARDIGLIO CENERE

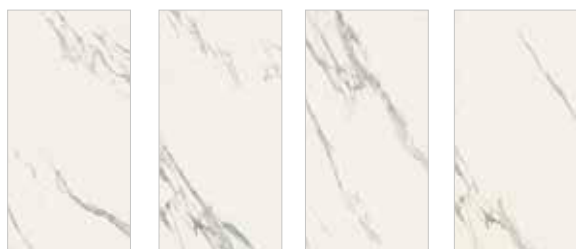

CALACATTA



CALACATTA Slab A

CALACATTA Slab B

CALACATTA Slab A

CALACATTA Slab B



CREMA MARFIL



SHADE SPECTRUM

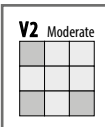

□ Naturale e rettificato.
Natural and rectified.
Naturel et rectifié.

Natur Oberfläche und kalibriert.
Natural y rectificado.
Натуральный ректифицированный.
天然和抛光。

○ Lappato e rettificato.
Lappato and rectified.
Lappato et rectifié.
Lappato und kalibriert.
Lappato y rectificado.

Лаппатированный ректифицированный.
亚光和抛光。

■ Naturale.
Natural.
Naturel.
Natur natur.
Natural.
Натуральный.
天然。

● Lappato con bordi naturali.
Lappato with non rectified edges.
Lappato à bords naturels.

Lappato mit natürlichen Kanten.
Pulido con los bordes natural.
Лаппатированная поверхность с матовой кромкой.
抛光带天然磨边。

		320x160 126"x63" 6 mm	240x120 96"x48" 6 mm	160x160 63"x63" 6 mm	120x120 48"x48" 6 mm	160x80 63"x31 1/2" 6 mm	240x80 96"x31 1/2" 6 mm	80x80 31 1/2"x31 1/2" 6 mm	120x60 48"x24" 10 mm	60x60 24"x24" 10 mm	324x163 127"x64" 12 mm
Bardiglio Cenere	○ Lap. Ret. 6mm	087005	087025	087045	087065	087085	087533	087105	-	-	-
	□ Nat. Ret. 6mm	087006	087026	087046	087066	087086	-	087106	-	-	-
	○ Lap. Ret. 10mm	-	-	-	-	-	-	-	087125	087145	-
	□ Nat. Ret. 10mm	-	-	-	-	-	-	-	087126	087146	-
	● Lap. Nat. 12mm	-	-	-	-	-	-	-	-	-	087905
	■ Nat. 12mm	-	-	-	-	-	-	-	-	-	087906
Calacatta	○ Lap. Ret. 6mm	083005	083015	083025	083035	083045	-	083055	-	-	-
	□ Nat. Ret. 6mm	083006	083016	083026	083036	083046	-	083056	-	-	-
	○ Lap. Ret. 10mm	-	-	-	-	-	-	-	083065	083085	-
	□ Nat. Ret. 10mm	-	-	-	-	-	-	-	083066	083086	-
	● Lap. Nat. 12mm	-	-	-	-	-	-	-	-	-	083901
	■ Nat. 12mm	-	-	-	-	-	-	-	-	-	083902
Slab A	○ Lap. Ret. 6mm	083093	083112	-	-	-	-	-	-	-	-
Slab B	○ Lap. Ret. 6mm	083094	083113	-	-	-	-	-	-	-	-
Crema Marfil	○ Lap. Ret. 6mm	083009	083019	083029	083039	083049	083557	083059	-	-	-
	□ Nat. Ret. 6mm	083010	083020	083030	083040	083050	-	083060	-	-	-
	○ Lap. Ret. 10mm	-	-	-	-	-	-	-	083069	083087 <i>*(min. 2.000 mq)</i>	-
	□ Nat. Ret. 10mm	-	-	-	-	-	-	-	083070	083088 <i>*(min. 2.000 mq)</i>	-

Lo spessore della lastra stuoiata è 12,7 mm. The thickness of the mesh-mounted slab is 12,7 mm. L'épaisseur de la dalle montée sur filet est de 12,7 mm. Die Dicke der Platte mit Netz ist 12,7 mm. El espesor de las losas, malla incluida, es de 12,7 mm. Толщина плиты с сеткой составляет 12,7 мм. 铺垫后的板材厚度为12.7毫米。

*Articolo disponibile per progetti (ordine minimo circa 2.000mq). Article available for large-scale projects (minimum order: approximately 2,000 m²). Article disponible pour les projets (commande minimale environ 2000 m²). Für Projekte verfügbarer Artikel (Mindestbestellung ca. 2.000 qm.). Artículo disponible para proyectos (pedido mínimo aproximadamente 2.000 m²). Этот артикул поставляется для крупных проектов (минимальный заказ – около 2000 кв.м.). 依项目而定的产品 (最小订单约2000平米)。

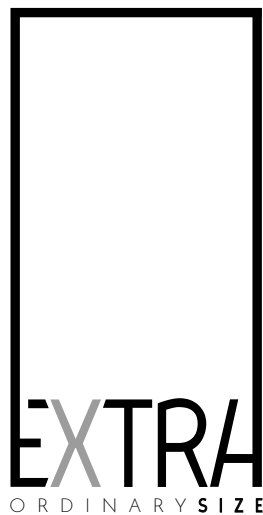

LASTRE IN GRES PORCELLANATO PRESSATE A SECCO.

Dry-pressed porcelain stoneware slabs.
Dalles en grès cérame pressées à sec.
Trockengepresste Platten aus Feinsteinzeug.
Planchas en gres porcelánico prensadas en seco.
Керамогранитные плиты сухого прессования. 干压陶瓷砖。

UNI EN 14411-ISO 13006 appendice C gruppo BIa - UGL

Grande varietà nelle grafiche per un pavimento o rivestimento sempre vario a effetto "naturale". The collection is available in a wide variety of graphics for varied floor or wall solutions with a "natural" effect. Grande variété des graphiques pour un carrelage de sol ou un revêtement mural toujours différent et un effet "naturel". Große Vielfalt der Graphiken für einen ständig unterschiedlichen Boden- oder Wandbelag mit "natürlichem" Effekt. Gran variedad en las gráficas para un pavimento o revestimiento siempre diferente de efecto "natural". Предлагается большое разнообразие рисунков для укладки всегда меняющегося пола или облицовки с натуральным эффектом. 多样的图案让地板和涂层具有不同的“天然”色彩。

Spessore. Thickness. Epaisseur. Stärke. Espesor. Толщина. 厚度 **6mm - 10mm - 12mm**

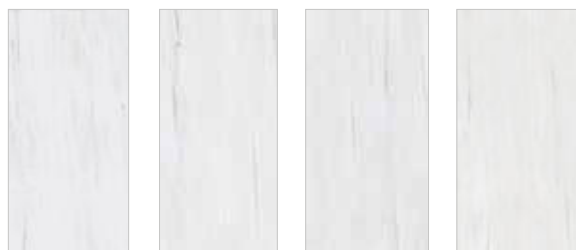

LASA



NERO BELVEDERE

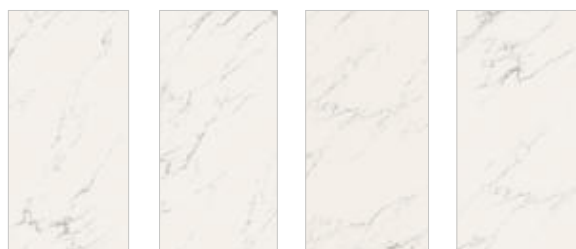

STATUARIO

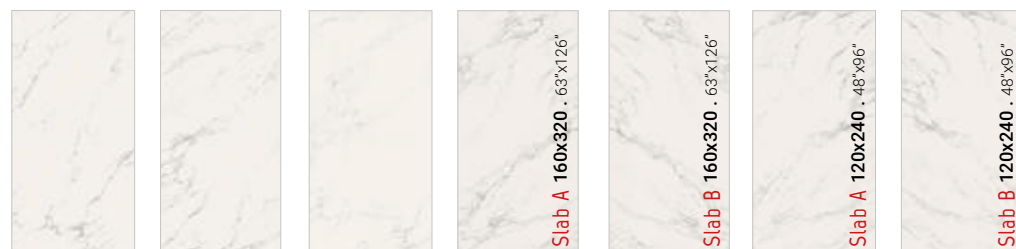

STATUARIO Slab A

STATUARIO Slab B

STATUARIO Slab A

STATUARIO Slab B

SHADE SPECTRUM

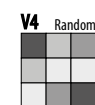
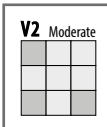
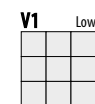

□ **Naturale e rettificato.**
Natural and rectified.
Naturel et rectifié.
Natur Oberfläche und kalibriert.
Natural y rectificado.
Натуральный ректифицированный.
天然和抛光。

○ **Lappato e rettificato.**
Lappato and rectified.
Lappato et rectifié.
Lappato und kalibriert.
Lappato y rectificado.
Лаппатированный ректифицированный.
亚光和抛光。

■ **Naturale.**
Natural.
Naturel.
Natur natur.
Natural.
Натуральный.
天然。

● **Lappato con bordi naturali.**
Lappato with non rectified edges.
Lappato à bords naturels.
Lappato mit natürlichen Kanten.
Pulido con los bordes natural.
Лаппатированная поверхность с матовой кромкой.
抛光带天然磨边。

			320x160 126"x63" 6 mm	240x120 96"x48" 6 mm	160x160 63"x63" 6 mm	120x120 48"x48" 6 mm	160x80 63"x31 1/2" 6 mm	240x80 96"x31 1/2" 6 mm	80x80 31 1/2"x31 1/2" 6 mm	120x60 48"x24" 10 mm	60x60 24"x24" 10 mm	324x163 127"x64" 12 mm
Lasa	○ Lap. Ret. 6mm	087003	087023	087043	087063	087083	-	087103	-	-	-	-
	□ Nat. Ret. 6mm	087004	087024	087044	087064	087084	-	087104	-	-	-	-
	○ Lap. Ret. 10mm	-	-	-	-	-	-	-	087123	087143	-	-
	□ Nat. Ret. 10mm	-	-	-	-	-	-	-	087124	087144	-	-
Nero Belvedere	○ Lap. Ret. 6mm	087013	087033	087049	087069	087089	-	087109	-	-	-	-
	○ Lap. Ret. 10mm	-	-	-	-	-	-	-	087129	087149	-	-
Statuario	○ Lap. Ret. 6mm	083003	083013	083023	083033	083043	-	083053	-	-	-	-
	□ Nat. Ret. 6mm	083004	083014	083024	083034	083044	-	083054	-	-	-	-
	○ Lap. Ret. 10mm	-	-	-	-	-	-	-	083063	083083	-	-
	□ Nat. Ret. 10mm	-	-	-	-	-	-	-	083064	083084	-	-
Slab A	○ Lap. Ret. 6mm	083091	083110	-	-	-	-	-	-	-	-	-
Slab B	○ Lap. Ret. 6mm	083092	083111	-	-	-	-	-	-	-	-	-

Lo spessore della lastra stuoiata è 12,7 mm. The thickness of the mesh-mounted slab is 12,7 mm. L'épaisseur de la dalle montée sur filet est de 12,7 mm. Die Dicke der Platte mit Netz ist 12,7 mm. El espesor de las losas, malla incluida, es de 12,7 mm. Толщина плиты с сеткой составляет 12,7 мм. 铺垫后的板材厚度为12.7毫米。

*Articolo disponibile per progetti (ordine minimo circa 2.000mq). Article available for large-scale projects (minimum order: approximately 2,000 m²). Article disponible pour les projets (commande minimale environ 2000 m²). Für Projekte verfügbarer Artikel (Mindestbestellung ca. 2.000 qm.). Artículo disponible para proyectos (pedido mínimo aproximadamente 2.000 m²). Этот артикул поставляется для крупных проектов (минимальный заказ – около 2000 кв.м.). 依项目而定的产品 (最小订单约2000平米)。

EXTRA

ORDINARY SIZE

LASTRE IN GRES PORCELLANATO PRESSATE A SECCO.

Dry-pressed porcelain stoneware slabs.
Dalles en grès cérame pressées à sec.
Trockengepresste Platten aus Feinsteinzeug.
Planchas en gres porcelánico prensadas en seco.
Керамогранитные плиты сухого прессования. 干压陶瓷砖。

UNI EN 14411-ISO 13006 appendice C gruppo BIa - UGL

Grande varietà nelle grafiche per un pavimento o rivestimento sempre vario a effetto "naturale". The collection is available in a wide variety of graphics for varied floor or wall solutions with a "natural" effect. Grande variété des graphiques pour un carrelage de sol ou un revêtement mural toujours différent et un effet "naturel". Große Vielfalt der Graphiken für einen ständig unterschiedlichen Boden- oder Wandbelag mit "natürlichem" Effekt. Gran variedad en las gráficas para un pavimento o revestimiento siempre diferente de efecto "natural". Предлагается большое разнообразие рисунков для укладки всегда меняющегося пола или облицовки с натуральным эффектом. 多样的图案让地板和涂层具有不同的“天然”色彩。

Spessore. Thickness. Epaisseur. Stärke. Espesor. Толщина. 厚度 6mm - 10mm - 12mm

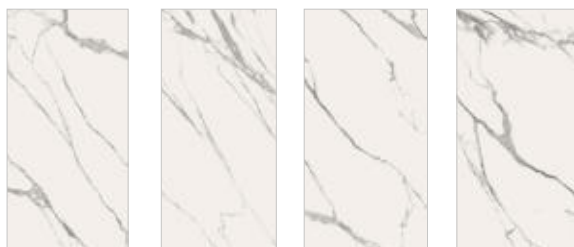

STATUARIO SPLENDEnte



STATUARIO SPLENDEnte Slab A

STATUARIO SPLENDEnte Slab B

STATUARIO SPLENDEnte Slab A

STATUARIO SPLENDEnte Slab B



TRAVERTINO SILVER



WHITE MACAUBA



SHADE SPECTRUM

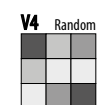
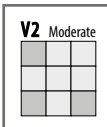
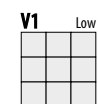

□ Naturale e rettificato.
Natural and rectified.
Naturel et rectifié.
Natur Oberfläche und kalibriert.
Natural y rectificado.
Натуральный ректифицированный.
天然和抛光。

○ Lappato e rettificato.
Lappato and rectified.
Lappato et rectifié.
Lappato und kalibriert.
Lappato y rectificado.
Лапатированный ректифицированный.
亚光和抛光。

■ Naturale.
Natural.
Naturel.
Natur natur.
Natural.
Натуральный.
天然。

● Lappato con bordi naturali.
Lappato with non rectified edges.
Lappato à bords naturels.
Lappato mit natürlichen Kanten.
Pulido con los bordes natural.
Лапатированная поверхность с матовой кромкой.
抛光带天然磨边。

			320x160 126"x63" 6 mm	240x120 96"x48" 6 mm	160x160 63"x63" 6 mm	120x120 48"x48" 6 mm	160x80 63"x31 1/2" 6 mm	240x80 96"x31 1/2" 6 mm	80x80 31 1/2"x31 1/2" 6 mm	120x60 48"x24" 10 mm	60x60 24"x24" 10 mm	324x163 127"x64" 12 mm
Statuario Splendente	○ Lap. Ret.	6mm	087007	087027	087047	087067	087087	087532	087107	-	-	-
	□ Nat. Ret.	6mm	087008	087028	087048	087068	087088	-	087108	-	-	-
	○ Lap. Ret.	10mm	-	-	-	-	-	-	-	087127	087147	-
	□ Nat. Ret.	10mm	-	-	-	-	-	-	-	087128	087148	-
	● Lap. Nat.	12mm	-	-	-	-	-	-	-	-	-	087908
	■ Nat.	12mm	-	-	-	-	-	-	-	-	-	087913
Slab A	○ Lap. Ret.	6mm	087009	087029	-	-	-	-	-	-	-	-
Slab B	○ Lap. Ret.	6mm	087011	087031	-	-	-	-	-	-	-	-
Travertino Silver	○ Lap. Ret.	6mm	087019	087037	087053	087073	087093	-	087113	-	-	-
	○ Lap. Ret.	10mm	-	-	-	-	-	-	-	087132	087152	-
White Macauba	○ Lap. Ret.	6mm	087017	087036	087052	087072	087092	-	087112	-	-	-
	○ Lap. Ret.	10mm	-	-	-	-	-	-	-	087131	087151	-

Lo spessore della lastra stuoiata è 12,7 mm. The thickness of the mesh-mounted slab is 12,7 mm. L'épaisseur de la dalle montée sur filet est de 12,7 mm. Die Dicke der Platte mit Netz ist 12,7 mm. El espesor de las losas, malla incluida, es de 12,7 mm. Толщина плиты с сеткой составляет 12,7 мм. 铺垫后的板材厚度为12.7毫米。

*Articolo disponibile per progetti (ordine minimo circa 2.000mq). Article available for large-scale projects (minimum order: approximately 2,000 m²). Article disponible pour les projets (commande minimale environ 2000 m²). Für Projekte verfügbarer Artikel (Mindestbestellung ca. 2.000 qm.). Artículo disponible para proyectos (pedido mínimo aproximadamente 2.000 m²). Этот артикул поставляется для крупных проектов (минимальный заказ – около 2000 кв.м.). 依项目而定的产品 (最小订单约2000平米)。

DECORI

Decors . Décors . Dekore . Decoraciones . Декоры . 飾

Mosaico

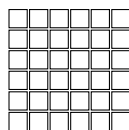

30x30cm. 12"x12" Lap. Ret.
thickness 6mm

* PEZZI SPECIALI

Trims . Pièces spéciales . Formstücke . Piezas especiales . Специальные элементы . 特别部件

COSTA RETTA:

Straight nose:

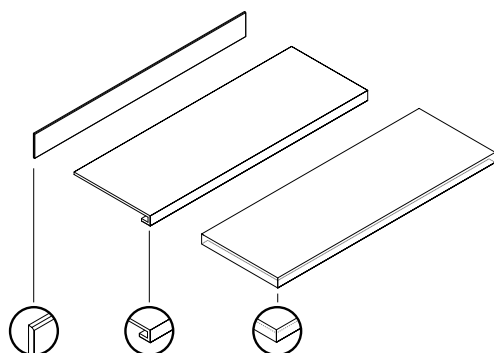

Scuretto
Rabbeted
riser

Gradino
costa retta
Straight
nosed stair

Gradino
costa retta angolo
Straight nosed
corner step

Gradino Costa Retta
160x33x3,2h - 63"x13"x1 1/4"h

Gradino Costa Retta
120x33x3,2h - 48"x13"x1 1/4"h

Gradino Costa Retta
80x33x3,2h - 31 1/2"x13"x1 1/4"h

Gradino Costa Retta Dx/Sx
160x33x3,2h - 63"x13"x1 1/4"h

Gradino Costa Retta Dx/Sx
120x33x3,2h - 48"x13"x1 1/4"h

Gradino Costa Retta Dx/Sx
80x33x3,2h - 31 1/2"x13"x1 1/4"h

BORDO DRITTO:

Straight edge:

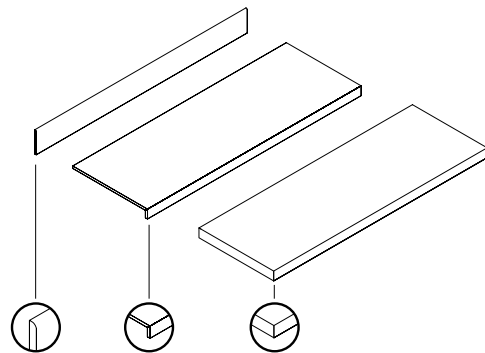

Battiscopa
Skirting

Gradino
bordo dritto
Straight-edge
step

Gradino
bordo dritto angolo
Straight-edge
corner step

Gradino Bordo Dritto
160x30x4h - 63"x12"x1 1/2"h

Gradino Bordo Dritto
120x30x4h - 48"x12"x1 1/2"h

Gradino Bordo Dritto
80x30x4h - 31 1/2"x12"x1 1/2"h

Gradino Bordo Dritto Dx/Sx
160x30x4h - 63"x12"x1 1/2"h

Gradino Bordo Dritto Dx/Sx
120x30x4h - 48"x12"x1 1/2"h

Gradino Bordo Dritto Dx/Sx
80x30x4h - 31 1/2"x12"x1 1/2"h

*

A disposizione solo su richiesta. Tempi di consegna: 30gg.

Available upon request only. Delivery terms: 30 days.
Disponible seulement sur requête. Délais de livraison: 30 jours.
Verfügbar auf Anfrage. Lieferzeit: 30 Tage.
Disponibile sólo bajo pedido. Plazo de entrega: 30 días.
Изготавливается только по специальной заявке.
Срок поставки: 30 дней.
仅依订购。交货时间: 30日。

Per il gradino non si garantisce la stessa tonalità del fondo.

We cannot guarantee that the shade of the stair tile will be the same as the background tile.
Pour la marche, nous ne garantissons pas la même tonalité du fond.
Für die Stufe wird nicht der gleiche Farbton des Untergrunds garantiert.
Para el peldaño no se garantiza el mismo tono del fondo.
Для ступени не гарантирована одинаковость тона с фоном.
对于台阶不保证底色一致。

		Battiscopa Skirting 120x6,5 48"x2 1/2"	Battiscopa Skirting 80x8 31 1/2"x3"	Scuretto Rabbeted riser 160x20 63"x8"	Scuretto Rabbeted riser 120x20 48"x8"	Scuretto Rabbeted riser 80x20 31 1/2"x8"
Arabasque	o Lap. Ret. 10 mm	✓	-	-	✓	-
	o Lap. Ret. 6 mm	-	✓	✓	-	✓
Azul Macaua	o Lap. Ret. 10 mm	✓	-	-	✓	-
	□ Nat. Ret. 10 mm	-	-	-	-	-
	o Lap. Ret. 6 mm	-	✓	✓	-	✓
Bianco Bernini	□ Nat. Ret. 6 mm	-	✓	✓	-	✓
	o Lap. Ret. 10 mm	✓	-	-	✓	-
	□ Nat. Ret. 10 mm	-	-	-	-	-
Bardiglio Cenere	o Lap. Ret. 6 mm	-	✓	✓	-	✓
	□ Nat. Ret. 6 mm	-	✓	✓	-	✓
	o Lap. Ret. 10 mm	✓	-	-	✓	-
	□ Nat. Ret. 10 mm	✓	-	-	✓	-
Calacatta	o Lap. Ret. 6 mm	-	✓	✓	-	✓
	□ Nat. Ret. 6 mm	-	✓	✓	-	✓
	o Lap. Ret. 10 mm	✓	-	-	✓	-
	□ Nat. Ret. 10 mm	✓	-	-	✓	-
Crema Marfil	o Lap. Ret. 6 mm	-	✓	✓	-	✓
	□ Nat. Ret. 6 mm	-	✓	✓	-	✓
	o Lap. Ret. 10 mm	✓	-	-	✓	-
	□ Nat. Ret. 10 mm	✓	-	-	✓	-
Lasa	o Lap. Ret. 6 mm	-	✓	✓	-	✓
	□ Nat. Ret. 6 mm	-	✓	✓	-	✓
	o Lap. Ret. 10 mm	✓	-	-	✓	-
	□ Nat. Ret. 10 mm	✓	-	-	✓	-
Nero Belvedere	o Lap. Ret. 6 mm	-	✓	✓	-	✓
	o Lap. Ret. 10 mm	✓	-	-	✓	-
Statuario	o Lap. Ret. 6 mm	-	✓	✓	-	✓
	□ Nat. Ret. 6 mm	-	✓	✓	-	✓
	o Lap. Ret. 10 mm	✓	-	-	✓	-
	□ Nat. Ret. 10 mm	✓	-	-	✓	-
Statuario Splendente	o Lap. Ret. 6 mm	-	✓	✓	-	✓
	□ Nat. Ret. 6 mm	-	✓	✓	-	✓
	o Lap. Ret. 10 mm	✓	-	-	✓	-
	□ Nat. Ret. 10 mm	✓	-	-	✓	-
Travertino Silver	o Lap. Ret. 6 mm	-	✓	✓	-	✓
	o Lap. Ret. 10 mm	✓	-	-	✓	-
White Macaua	o Lap. Ret. 6 mm	-	✓	✓	-	✓
	o Lap. Ret. 10 mm	✓	-	-	✓	-

o **Lappato e rettificato.** Lappato and rectified. Lappato et rectifié. Lappato und kalibriert. Lappato y rectificado.
Лаппатированный ректифицированный. 亚光和抛光。

□ **Naturale e rettificato.** Natural and rectified. Naturel et rectifié. Natur Oberfläche und kalibriert. Natural y rectificado.
Натуральный ректифицированный. 天然和抛光。

IMBALLI

Package . Emballage . Verpackung . Embalajes . Упаковка . 涂料.

FORMATO cm. Size	SPESSORE. Thickness	TIPOLOGIA IMBALLO. Type of packing	LASTRE Slabs	MQ LASTRA Sqm Slab	KG LASTRA Kg Slab	MQ. Sqm	KG Kg	TARA Tare
324x163	12 mm	Cassa / Crate 345x175x37	10	5,28	152,47	52,80	1.665	140,00
		Cavalletto in legno / Wood A-Frame 330x75x193,5	22			116,16	3.564	210,00
		Cavalletto in ferro / Iron A-Frame 330x75x193,5	22			116,16	3.613	259,00
320x160	6 mm	Cassa / Crate 345x175x37	14	5,12	74,14	71,68	1.178	140,00
		Cavalletto in legno / Wood A-Frame 330x75x193,5	44			225,28	3.472	210,00
160x160	6 mm	Cassa / Crate 182,6x173,6x40,4	24	2,56	37,07	61,44	962	71,80
		Cavalletto in legno / Wood A-Frame 330x75x193,5	88			225,28	3.472	210,00
240x120	6 mm	Cassa / Crate 264x136x40	20	2,88	41,70	57,60	934	100,00
		Cavalletto in legno / Wood A-Frame 250x75x153,5	44			126,72	1.993	158,00
120x120	6 mm	Cavalletto in legno / Wood A-Frame 250x75x153,5	88	1,44	20,85	126,72	1.993	158,00
240x80	6 mm	Cassa / Crate 265x96x47	30	1,92	27,80	57,60	912	78,00
		Cavalletto in legno / Wood A-Frame 250x75x153,5	44			84,48	1.381	158,00
160x80	6 mm	Pallet speciale con sponde / Special pallet with sides 168x97x40,9	30	1,28	18,60	38,40	603	45,00

FORMATO cm. Size	SPESSORE. Thickness	TIPOLOGIA IMBALLO. Type of packing	PZ. X SCAT. Pieces x Box	MQ. X SCAT. Sqm x Box	KG X SCAT. Weight x Box	SCAT. X PAL. Boxes x Pal.	MQ. X PAL. Sqm x Pal.	KG X PAL. Weight x Pal.
120x120	6 mm	Pallet speciale con sponde / Special pallet with sides 143x123x64,7	2	2,88	41,70	24	69,12	1.057
80x80	6 mm	Europallet 80x120	3	1,92	27,90	40	76,80	1.141
120x60	10 mm	Europallet 80x120	2	1,44	33,41	30	43,20	1.025
60x60	10 mm	Europallet 80x120	3	1,08	24,80	40	43,20	1.012

I pesi riportati in tabella sono indicativi in quanto possono subire leggere variazioni per motivi produttivi.
The weights stated in the chart are approximate as some changes may be necessary for production reasons.
Les poids figurant dans le tableau sont fournis à titre indicatif car ils peuvent subir de légères variations pour des raisons de production.
Die in der Tabelle aufgeführten Gewichte sind nicht bindend, da sie aus Produktionsgründen leichte Änderungen aufweisen können.

Le condizioni generali di vendita, gli schemi ed i consigli di posa sono consultabili sul sito www.avaceramica.it.
The general conditions of sale, together with the laying diagrams and tips are available on the website www.avaceramica.it.
Les conditions générales de vente, les schémas et les conseils de pose peuvent être consultés sur le site www.avaceramica.it.
Die allgemeinen Verkaufsbedingungen, die Schemen und die Verlegeratschläge befinden sich in der Website www.avaceramica.it.

Los pesos señalados en la tabla son aproximados ya que pueden experimentar ligeras variaciones por motivos productivos.
Указанный в таблице вес является приблизительным, так как ввиду производственных потребностей, он может слегка измениться.
表格记载的重量只具有提示意义, 因为可能在生产过程中产生轻微的偏差。

Las condiciones generales de venta, los esquemas y los consejos para la colocación pueden ser consultados en el sitio www.avaceramica.it.
На сайте www.avaceramica.it вы можете ознакомиться с общими условиями продажи, схемами и рекомендациями по укладке.

CERTIFICAZIONI DI PRODOTTO

Product certification . Certification de produit . Produkt Zertifizierungen . Certificaciones de producto . Сертификация . 产品认证 .

100% DESIGN
AND PRODUCTION
OF ITALY



放射性水平 A 类

Certificazione obbligatoria per l'esportazione in Cina
Certification mandatory for export to China
Certification obligatoire pour l'exportation en Chine
Für den Export nach China obligatorische Zertifizierung
Certificación obligatoria para la exportación a China
Обязательная сертификация для экспорта в Китай

Ceramics of Italy



Azienda Certificata
Certified Company

CARATTERISTICHE TECNICHE

Technical features . Caracteristiques techniques . Technische Eigenschaften . Caracteristicas tecnicas . Технические характеристики . 技术特点 .

LASTRE IN GRES PORCELLANATO PRESSATE A SECCO. Classificazione secondo UNI EN 14411-ISO 13006 - G - Bla (E ≤ 0,5%) UGL

Dry-pressed porcelain stoneware slabs. Product in compliance with UNI EN 14411-ISO 13006 - G - Bla (E ≤ 0,5%) UGL













Dalles en grès cérame pressées à sec. Classement selon UNI EN 14411-ISO 13006 - G - Bla (E ≤ 0,5%) UGL

Trockengepresste Platten aus Feinsteinzeug. Klassifizierung nach UNI EN 14411-ISO 13006 - G - Bla (E ≤ 0,5%) UGL

Planchas en grés porcelánico prensadas en seco. Clasificación según UNI EN 14411-ISO 13006 - G - Bla (E ≤ 0,5%) UGL

Керамогранитные плиты сухого прессования. Классификация согласно европейской сертификации UNI EN 14411-ISO 13006 - G - Bla (E ≤ 0,5%) UGL

干燥压制瓷制砖. 根据UNI EN 14411-ISO 13006 - G - Bla (E ≤ 0,5%) UGL的分类

	CARATTERISTICA Specification Caracteristique Eigenschaft Característica Характеристика 功能	METODO DI PROVA Test methods Methode d'essai Testverfahren Prueba Стандарт испытаний 方法测试	VALORE PRESCRITTO Fixed value Valeur prescrite Vorgeschriebener Wert Valor prescrito Требуемых значений 指引	
	Caratteristiche dimensionali - Dimensional characteristics - Dimensions - Dimensionale Eigenschaften Características dimensionales - Пространственные характеристики - 尺寸特性	ISO 10545-2		Conforme Compliant - Conforme - Erfüllt - Cumple Соответствует - 符合性
	Assorbimento d'acqua - Water absorbtion - Absortion d'eau - Wasseraufnahme Absorción de agua - Водопоглощение - 吸水率	ISO 10545-3	≤ 0,5 %	Conforme Compliant - Conforme - Erfüllt - Cumple Соответствует - 符合性
	Resistenza alla flessione - Breaking modulus - Resistance a la flexion - Biegefestigkeit Resistencia a la flexión - прочность на изгиб - 弯曲强度		≥ 35 N/mm ²	Conforme Compliant - Conforme - Erfüllt - Cumple Соответствует - 符合性
	Sforzo di rottura - Modulus of rupture - Charge de rupture - Bruchlast - Esfuerzo de rotura Стойкость на изгиб - 断裂应力	ISO 10545-4	≥ 7,5 mm = ≥ 1300 N < 7,5 mm = ≥ 700 N	Conforme Compliant - Conforme - Erfüllt - Cumple Соответствует - 符合性
	Resistenza alla abrasione profonda - Deep abrasion resistance - Resistance a l'abrasion profonde Beständigkeit gegen Tiefenverschleiß - Resistencia a la abrasión profunda - Устойчивость к глубокому стиранию по - 深层磨损耐性	ISO 10545-6	≤ 175 mm ³	Conforme Compliant - Conforme - Erfüllt - Cumple Соответствует - 符合性
	Coefficiente di dilatazione termica lineare - Thermal expansion coefficient - Coefficient de dilatation thermique lineaire - Warmausdehnungskoeffizient - Coefficiente de dilatación térmica lineal зкоэффициент теплового линейного расширения - 线性热膨胀系数	ISO 10545-8		≤ 7x10 ⁻⁶ °C ⁻¹
	Resistenza agli sbalzi termici - Thermal shock resistance - Resistance aux ecart de temperature Temperaturwechselbeständigkeit - Resistencia a choque térmico Устойчивость к темпепатурным перепадам - 抗热震性	ISO 10545-9		Resistenti Resistant - Résistants - Widerstandsfähig Resiste - устойчивы - 耐性
	Resistenza al gelo - Frost resistance - Resistance au gel - Frostbestaendigkeit - Resistencia al hielo Морозостойкость - 抗冻性	ISO 10545-12		Resistenti Resistant - Résistants - Widerstandsfähig Resiste - устойчивы - 耐性
	Resistenza ai prodotti chimici - Chemical resistance - Resistance aux produits chimiques Chemische Beständigkeit - Resistencia a los productos químicos - Химическая устойчивость - 耐化学腐蚀	ISO 10545-13	min. UB	Resistenti Resistant - Résistants - Widerstandsfähig Resiste - устойчивы - 耐性
	Prodotti chimici ad uso domestico ed additivi per piscina - Household chemicals and swimming pool water cleansers - Produits chimiques courants et additifs pour piscine - Chem.Produkte für den Haushaltsgebrauch und Zusatz für Schwimmbäder - Productos químicos para uso doméstico y con aditivos para piscina - бытовые химические средства и средства для бассейнов - 家用化学产品和游泳池添加剂			
	Acidi ed alcali a bassa concentrazione - Acids and low concentration alkalis - Acides et alcali a faible concentration - Säuren und Alkali in geringer Konzentration - Ácidos y álcalis en baja concentración Низкоконцентрированные кислоты и щёлочи - 低浓度下酸碱度			
	Resistenza alle macchie - Stain resistance - Resistance aux taches - Fleckbeständigkeit Resistencia a las manchas - Устойчивость к загрязнению - 耐油污	ISO 10545-14		Resistenti Resistant - Résistants - Widerstandsfähig Resiste - устойчивы - 耐性
	Stabilità dei colori alla luce - Colour stability to light - Stabilité des couleurs a la lumiere Lichtechtheit der Farben - Estabilidad de los colores - Устойчивость цвета - 光颜色牢度	DIN 51094		Conforme Compliant - Conforme - Erfüllt - Cumple Соответствует - 符合性
	Coefficiente di attrito (scivolosità) Friction coefficient (slipperiness) - Coefficient de frottement (glissance) Reibungskoeffizient (Glätte) - Coeficiente de fricción (deslizabilidad) Коэффициент трения (скользкость) - 摩擦系数 (光滑度)	ANSI A 137.1:2012	≥ 0,42	≥ 0,42 Superficie naturale Natural surface

LA FABBRICA S.p.A. si riserva di apportare, senza alcun preavviso, le modifiche che riterrà più opportune al fine di migliorare il prodotto. Quanto riportato è da considerarsi indicativo e non esaustivo in riferimento ai colori e alle caratteristiche estetiche dei prodotti.

LA FABBRICA S.p.A. reserves the right to make any changes it deems fit in order to improve the product, without prior notice. All images are provided for illustrative purposes only and other colours and aesthetic features are available.



La Fabbrica S.p.A.
Via Emilia Ponente, 925
48014 Castel Bolognese (RA) Italy
Tel. +39 0546 - 659911
Fax +39 0546 - 656223
www.avaceramica.it
www.lafabbrica.it



www.avaceramica.it



www.lafabbrica.it

Follow us

